

COMPAC®

FABRIKANT SINDS 1946



CATALOGUS NR. 11A





Hoe Compac waarde creëert

4-7



Lage krikken 2 ton



Krikken voor goede toegang onder lage voertuigen 2 ton



Krikken voor busjes, 4WD's en minibussen 3 ton



Krikken met groot draagvermogen 4 - 15 ton



Hooglichters 1,4 - 2 ton

NIEUW PRODUCT



Hooglichters 3 - 10 ton



Luchthydraulische krikken

NIEUW PRODUCT



Luchthydraulische krikken

NIEUW PRODUCT



Hydraulische uitdeukset



Wielheffer voor auto's, busjes en 4WD's



Wielheffers voor vrachtwagens en bussen





Wielheffer voor landbouw- en graafmachines



20-21



Werkplaatskranen



22-23



**Universele transmissiekriks
 Accessoires voor transmissiekriks**



24-25



**Telescopische transmissiekriks
 voor auto's, busjes en 4WD's**



26



**Telescopische transmissiekriks
 voor vrachtwagens en bussen**



27



Veercompressor



28-29



**Voetbediende
 werkplaatspersen 16 - 25 ton**



30



**Handbediende
 werkplaatspersen 20 - 25 ton**



31



**Voetbediende
 werkplaatspersen 40 - 50 ton**



32



**Handbediende
 werkplaatspersen 40 - 100 ton**



33



**Elektrohydraulische
 werkplaatspersen 40 - 100 ton**



34-35



Assteunen 2 - 12 ton

Potkriks 3 - 50 ton



36

HOE COMPAC WAARDE CREEËRT **Lifting is serious business – We know!**

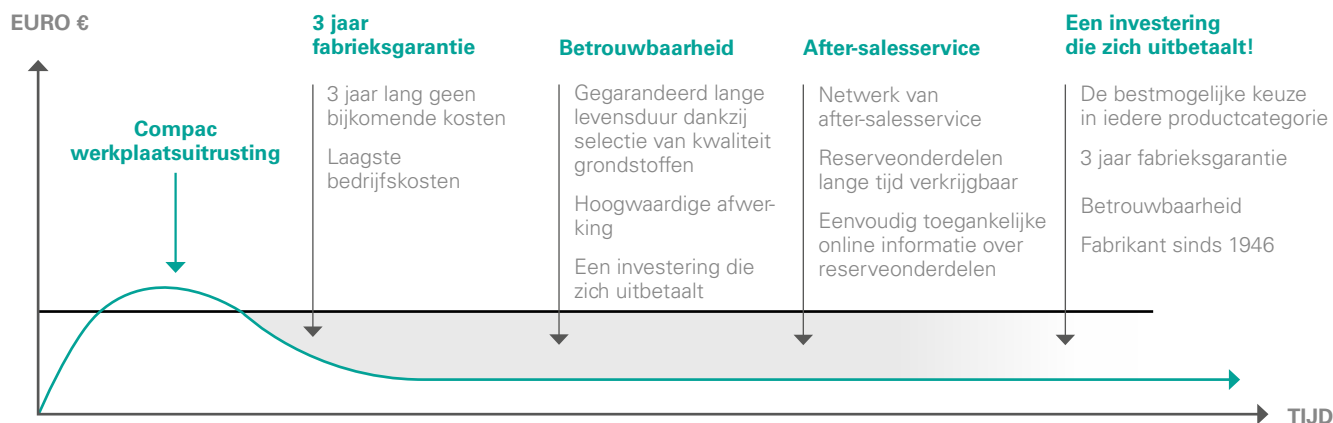

FABRIEKSGARANTIE

Compac is trendsetter binnen de branche. Als eerste fabrikant biedt Compac namelijk een volledige garantie van 3 jaar.





HISTORIE

Compac werd in 1946 opgericht door vier enthousiaste en bevlogen Denen. Hun visie: het maken van superieure hydraulische krikken. Nu, 70 jaar later, hebben we nog steeds dezelfde visie. En het is met trots dat we blijven werken aan de verdere versterking van onze reputatie op het gebied van superieure kwaliteit: een reputatie die we in de loop der jaren met grote zorg hebben opgebouwd.

KENNIS MAAKT HET VERSCHIL



FABRIKANT SINDS 1946

Compac produceert al sinds 1946 hydraulische producten van hoge kwaliteit. De ervaren technische medewerkers van Compac halen alles uit de kast om uitstekende kwaliteit te waarborgen en daarmee voor tevreden klanten te zorgen.





LANGDURIGE BESCHIKBAARHEID VAN RESERVEONDERDELEN

U kunt de reserve- en slijtageonderdelen van Compac-producten snel en eenvoudig identificeren en bijbestellen. Uitgebreide en overzichtelijke informatie over de reserveonderdelen van alle Compac-producten vindt u op www.compac.dk



ONLINE INFORMATIE

Snel toegang tot uitgebreide informatie over alle reserveonderdelen. Vind de juiste voordelen voor elke klus. YouTube-filmpjes ter verduidelijking van de voordelen voor de gebruiker. Gebruiksaanwijzingen. Probleemoplossingsgidsen met stapsgewijze instructies om u te helpen bij het ter plekke oplossen van eventuele functionele problemen.



UITSTEKENDE BASISMATERIALEN

De hydraulische componenten van Compac worden in eigen beheer vervaardigd met behulp van hoogwaardige materialen. Belangrijke basismaterialen, zoals de speciale hydraulische buizen, afdichtingen, kleppenblokken, enz., worden uitsluitend ingekocht bij gerenommeerde leveranciers van hoogwaardige basismaterialen. Compac sluit geen compromissen als het gaat om de kwaliteit van de essentiële basismaterialen die in haar hydraulische systemen worden verwerkt.

UNIEK KWALITEITSSYSTEEM

Compac werkt met een uniek kwaliteitssysteem dat is geïnspireerd op de Japanse benadering van kwaliteit. Het strenge kwaliteitssysteem gaat in op zowel de kwaliteitsgerichtheid als de persoonlijke verantwoordelijkheid van iedereen die bij het productieproces betrokken is.





LAGE KRIKKEN 2 TON AUTO'S



Ideaal voor hefpunten langs zijpanelen.



De ergonomisch gevormde greep biedt verbeterd bedieningscomfort.

Hef en draai veiligheidssysteem van de pomphendel voorkomt onbedoeld zakken.

Max. hoogte 500 mm.

Zwaar uitgevoerd, volgelaste modellen in hoge kwaliteit staal.

Voetpedaal voor snel heffen tot last.

Cilinderbeschermingshuls beschermt tegen vuil en lasspatten.

Min. hoogte 80 mm.



Lage bouwhoogte.

Veilig en gecontroleerd zakken, zelfs onder maximale belasting.

Overdrukventiel beschermt tegen overbelasting.

Geluidsarme nylon wielen.

ACCESSOIRES



1002LF

Rubber pad beschermt de vorm en coating van het hefpunt.



3068

Zadel voor extra hoogte en/of het bereiken van hefpunten achter spoilers etc. (+ 40 mm)



60245

Hardrubberen wielen. (Fabrieksgemonteerde)



Bogie PU

Geluidsarme polyurethaan wielen. (Fabrieksgemonteerde)

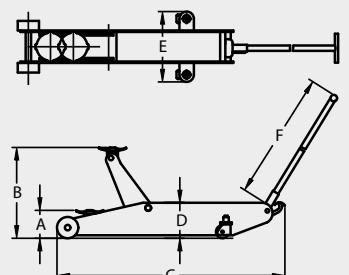

Model	Max (ton)	A (mm)	B (mm)	C (mm)	D (mm)	E (mm)	F (mm)	Kg
2T-C	2	80	500	730	160	380	925	37



KRIKKEN VOOR GOEDE TOEGANG ONDER LAGE VOERTUIGEN 2 TON AUTO'S



YouTube

Sleutelwoord:
Compac 2T-77



Extreem laag profiel en lange reikwijdte.
Ideaal voor voertuigen met lage spoilers of diep gelegen hefpunten.



Lang bereik van de krik verbetert de
bereikbaarheid van diep gelegen hefpunten.

Voetpedaal voor
snel heffen tot
last.

Lage bouwhoogte voor
bereik onder veel auto's.

Ultra lage
bouwhoogte
77 mm.



Lage bouwhoogte.

ACCESSOIRES



1077
Rubber pad beschermt
de vorm en coating van
het hefpunt.



3068
Zadel voor extra hoogte
en/of het bereiken van
hefpunten achter spoilers
etc. (+ 40 mm)



60245
Hardrubberen wielen.
(Fabrieksgemonteerde)



Bogie PU
Geluidsarme polyurethaan
wielen.
(Fabrieksgemonteerde)

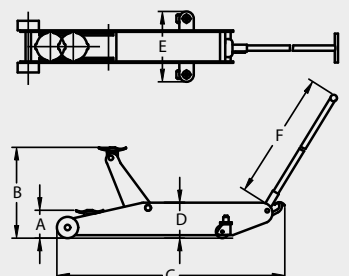

Model	Max (ton)	A (mm)	B (mm)	C (mm)	D (mm)	E (mm)	F (mm)	Kg
2T-77	2	77	480	950	126	380	925	41



KRIKKEN 3 TON

BUSJES, 4WD'S EN MINIBUSSEN



Door de lage bouwhoogte zijn diep en laag gelegen hefpunten van de meeste auto's bereikbaar.



ACCESSOIRES



1002LF
Rubber pad beschermt de vorm en coating van het hefpunt.



3068
Zadel voor extra hoogte en/of het bereiken van hefpunten achter spoilers etc. (+ 40 mm)

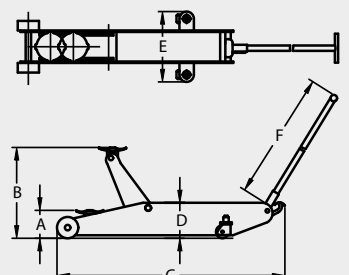

Model	Max (ton)	A (mm)	B (mm)	C (mm)	D (mm)	E (mm)	F (mm)	Kg
3T-C	3	115	500	1015	170	380	925	42



KRIKKEN MET GROOT DRAAGVERMOGEN 4 - 15 TON VRACHTWAGENS EN Bussen



Lang bereik van de krik verbetert de bereikbaarheid van diep gelegen hefpunten. **10T-C met accessoire 60200**

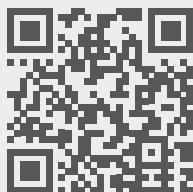

**You
Tube**

Sleutelwoord:
Compac 10TC

De ergonomisch gevormde greep biedt verbeterd bedieningscomfort.



Voetpedaal voor snel heffen tot last.

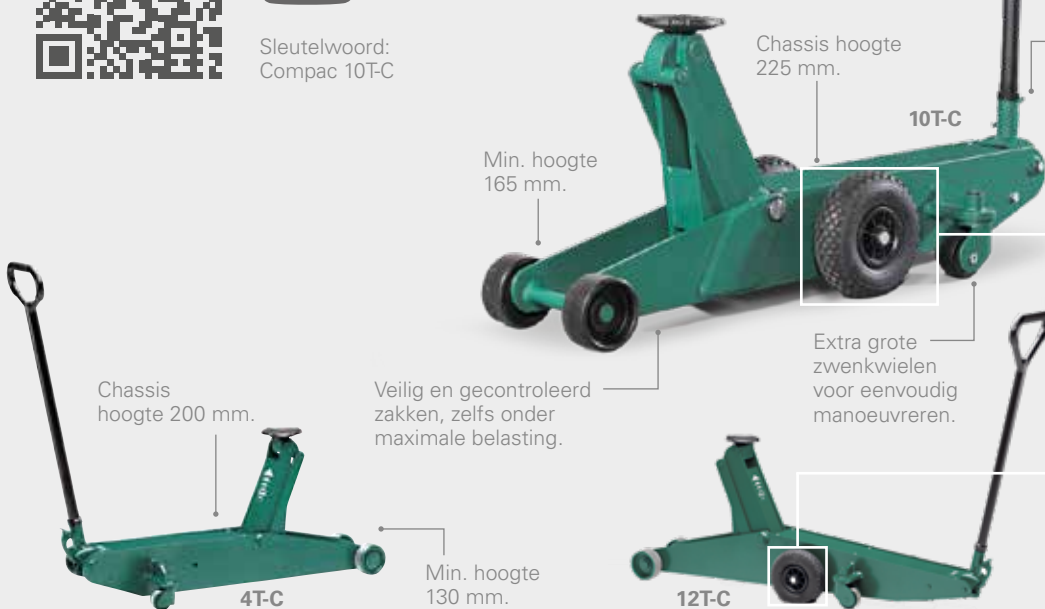

ACCESSOIRES



60200
Luchtbandenset bevestigd op het zwaartepunt verbetert de beweegbaarheid van grotere kriks. Banden zakken in bij belasting.

Model	Max (ton)	A (mm)	B (mm)	C (mm)	D (mm)	E (mm)	F (mm)	Kg
4T-C	4	130	545	1270	200	465	1045	70
5T-C	5	145	560	1270	200	465	1045	71
6T-C	6	155	570	1395	210	470	1045	90
10T-C	10	165	580	1410	225	435	1045	106
12T-C	12	170	670	1700	280	470	1045	150
15T-C	15	200	600	1790	325	475	1045	162

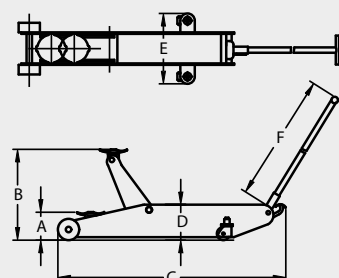



HOOGLICHTERS 1,4 - 2 TON AUTO'S



Max. hoogte 715 mm.

1,4T-HC 77

Voetpedaal voor snel heffen tot last.

Ultra lage bouwhoogte 77 mm.

ACCESSOIRES



Model	Nr.
-------	-----

1,4T-HC 77	1077
------------	------

2T-HC	1002LF
-------	--------

Rubber pad beschermt de vorm en coating van het hefpunt.



Bogie PU

Geluidsarme polyurethaan wielen.
(Fabrieksgemonteerde)



NIEUW PRODUCT

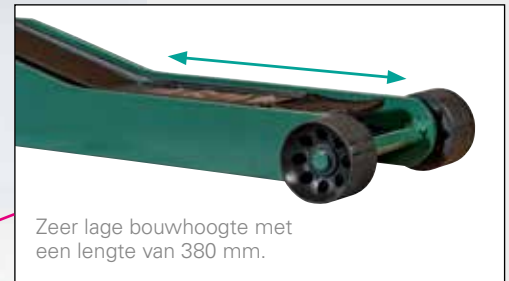

Zeer lage bouwhoogte met een lengte van 380 mm.

Veilig en gecontroleerd zakken, zelfs onder maximale belasting.

Door de lage profiel zijn diep en laag gelegen hefpunten van de meeste auto's bereikbaar.

Model	Max (ton)	A (mm)	B (mm)	C (mm)	D (mm)	E (mm)	F (mm)	Kg
1,4T-HC 77	1,4	77	715	1050	190	380	925	43
2T-HC	2	98	735	1035	200	380	1045	53

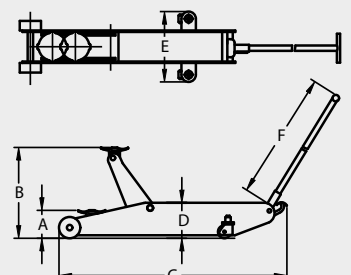



HOOGLICHTERS 3 - 10 TON

BESTELWAGENS EN LANDBOUWMACHINES



ACCESSOIRES



60200
Luchtbandenset bevestigd op het zwaartepunt verbetert de beweegbaarheid van grotere kriks. Banden zakken in bij belasting.

Max. hoogte 860 mm.

8T-HC with accessory 60200

De ergonomisch gevormde greep biedt verbeterd bedieningscomfort.

Hef en draai veiligheidssysteem van de pomphendel voorkomt onbedoeld zakken.

Max. hoogte 960 mm.

Veilig en gecontroleerd zakken, zelfs onder maximale belasting.

Zwaar uitgevoerd, volgelaste modellen in hoge kwaliteit staal.

Overdrukventiel beschermt tegen overbelasting.

Extra grote zwenkwielen voor eenvoudig manoeuvreren.



Voetpedaal voor snel heffen tot last.



3T-HC



8T-HC

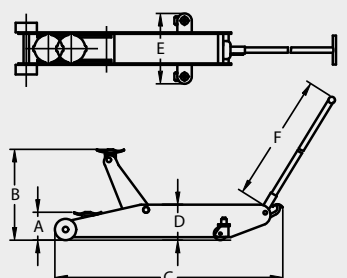

Model	Max (ton)	A (mm)	B (mm)	C (mm)	D (mm)	E (mm)	F (mm)	Kg
3T-HC	3	130	860	1620	210	460	1045	88
5T-HC	5	180	960	1830	350	475	1045	181
8T-HC	8	180	960	1830	350	475	1045	186
10T-HC	10	210	710	1700	290	475	1045	139



LUCHTHYDRAULISCHE KRIKKEN VRACHTWAGENS EN Bussen



A5816-C

LAGE TELESCOOPKRIK MET KORT CHASSIS EN EXTREEM LAGE TELESCOOPKRIK VOOR BUSSEN MET LAGE INSTAP



STANDAARD

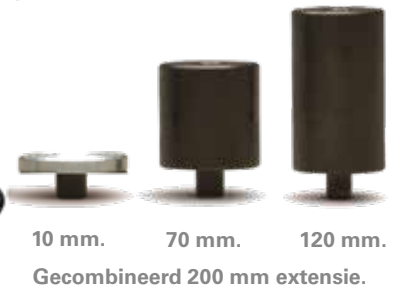

ACCESSOIRES

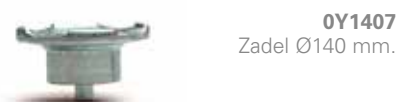
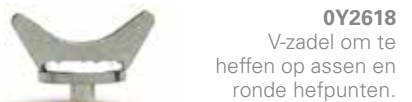
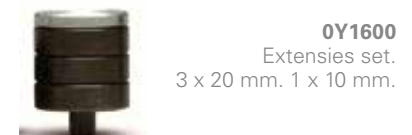

Sleutelwoord:
Compac A4020-C



Sleutelwoord:
Compac A5816-C

Model	Max (ton)	A (mm)	B1 (mm)	B2 (mm)	B3 (mm)	B4 (mm)	C (mm)	D (mm)	E (mm)	F (mm)	Kg
A3216-C	32/16	150	220	300	-	500	495	168	310	1230	43
A4020-C	40/20	150	220	300	-	500	495	168	310	1230	44
A5816-C	58/32/16	120	165	210	255	455	665	130	305	1360	52

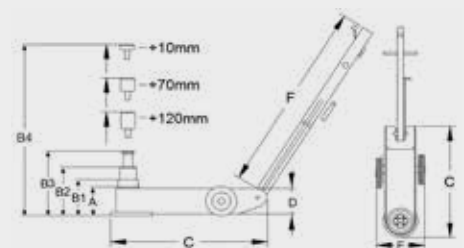



LUCHTHYDRAULISCHE KRIKken

VRACHTWAGENS EN LANDBOUWMACHINES



A28-HC

EXTRA HOGE LUCHTHYDRAULISCHE KRIK EN TELESCOOPKRIK MET EXTRA HOOG HEFVERMOGEN

Maximale hoogte 780 mm bij gebruik van de 3 verlengstukken.

Zware 1-traps cilinder met lange hefslag.

Langere hendel voor beter bereik.

Kort ontwerp voor makkelijk manoeuvreren.

NIEUW PRODUCT



A28-HC

A4422-C

Model	Max (ton)	A (mm)	B1 (mm)	B2 (mm)	B3 (mm)	B4 (mm)	C (mm)	D (mm)	E (mm)	F (mm)	Kg
A28-HC	28	350	580	-	-	780	735	160	280	1230	58
A4422-C	44/22	217	341	467	-	667	525	168	300	1230	46
A5830-C	58/30	220	330	450	-	650	1050	150	350	1360	80

STANDAARD



10 mm. 70 mm. 120 mm.

Gecombineerd 200 mm extensie.

ACCESSOIRES



0Y1600
Extensies set.
3 x 20 mm. 1 x 10 mm.



0Y2618
V-zadel om te heffen op assen en ronde hefpunten.



0Y1407
Zadel Ø140 mm.

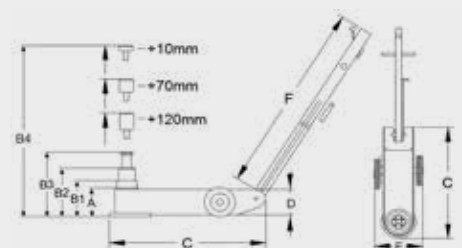



EXTREEM LAAG LUCHTHYDRAULISCH KRIK 1,6 TON AUTO'S



Lang bereik van de krik verbetert de bereikbaarheid van diep gelegen hefpunten.

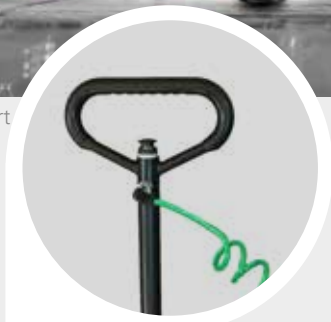

Snelle en stille luchtpomp. Minder dan 70 dB.



Max. hoogte 480 mm.

**NIEUW PRODUCT
LUCHTHYDRAULISCH**

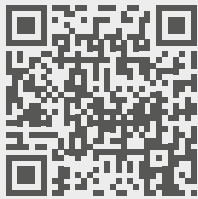

Sleutelwoord:
Compac A1,6T-77



Extreem laag profiel en lange reikwijdte. Ideaal voor voertuigen met lage spoilers of diep gelegen hefpunten.



Lage bouwhoogte voor bereik onder veel auto's.

Ultra lage bouwhoogte 77 mm.



Lage bouwhoogte.

ACCESSOIRES



1077
Rubber pad beschermt de vorm en coating van het hefpunt.



3068
Zadel voor extra hoogte en/of het bereiken van hefpunten achter spoilers etc. (+ 40 mm)



60245
Hardrubberen wielen. (Fabrieksgemonteerde)



Bogie PU
Geluidsarme polyurethaan wielen. (Fabrieksgemonteerde)

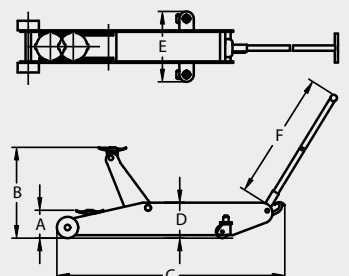

Model	Max (ton)	A (mm)	B (mm)	C (mm)	D (mm)	E (mm)	F (mm)	Kg
A1,6T-77	1,6	77	480	950	126	380	925	51



HYDRAULISCHE UITDEUKSET

AUTO'S, VRACHTWAGENS EN LANDBOUMMACHINES



	CRK 4	CRK 10
1	Quick-lock buis, 400 mm.	Quick-lock buis, 475 mm.
2	Quick-lock buis, 300 mm.	Quick-lock buis, 350 mm.
3	Quick-lock buis, 200 mm.	Quick-lock buis, 250 mm.
4	Quick-lock buis, 100 mm.	Quick-lock buis, 125 mm.
5	V-kop.	V-kop.
6	Teen-adaptor met schroefdraad.	Teen-adaptor met schroefdraad.
7	Hoekkop.	Hoekkop.
8	Wigkop.	Wigkop.
9	Basis.	Basis.
10	Zadel.	Zadel.
11	Flexibele rubberkop.	Flexibele rubberkop.
12	Connector.	Connector.
13	Spreider. (Max 500 kg.)	Spreider. (Max 500 kg.)
14	Cilinder.	Cilinder.
15	Flexibele slang, 1800 mm.	Flexibele slang, 1800 mm.
16	4 ton hydraulische voeding.	10 ton hydraulische voeding.
17	Koffer.	Koffer met wieltes.

! WAARSCHUWING: De capaciteit van het hydraulisch systeem overschrijdt het maximum van de spreider en andere adapters. Zie de gebruikshandleiding voor de maximumcapaciteit per component.



WIELHEFFER

AUTO'S, BUSJES EN 4WD'S

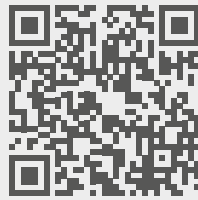
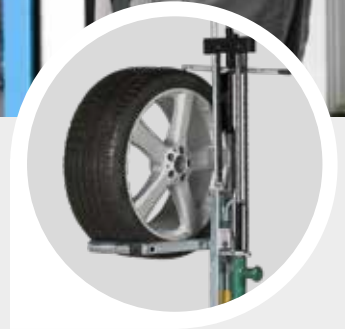
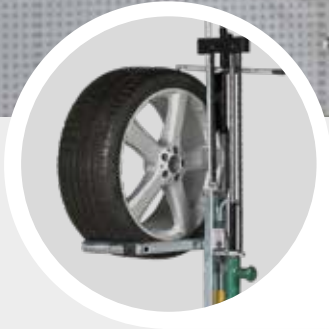

YouTube

Sleutelwoord:
Compac WD 60

Goede toegang tot wielbouten.
Het wiel bevindt zich aan de andere zijde van de hoofdzuiger.

Capaciteit: 60 kg.
(Buitendiameter max. 820 mm)



Rollen met kogellagers voor makkelijk draaien positioneren.



Heffen dankzij voetbediening.

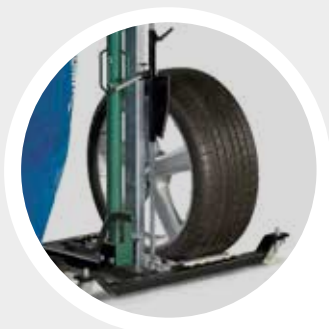

De wielheffer tilt het wiel rechtstreeks van de grond en voorkomt daarmee zwaar tilwerk.



WD 60

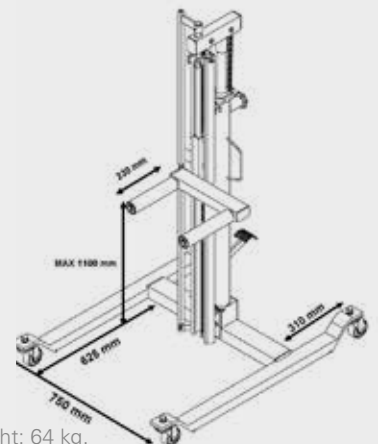

Gewicht: 64 kg.



WIELHEFFERS VRACHTWAGENS EN BUSSEN



IDEAAL VOOR ONDERHOUD AAN VRACHTWAGENS. MAKKELIJK EN VEILIG MONTEREN, DEMONTEREN EN HANTEREN VAN ZWARE WIELEN VAN VRACHTWAGENS EN BUSSEN

Extra steunwielen voor makkelijk en veilig manoeuvreren, ook bij volledige belading.

Kogelgelagerde rollers voor eenvoudig roteren en positioneren van de wielen op de navens.

Capaciteit 250 kg.

Gewicht: 15 kg.

WD Mobile



Dankzij de ergonomische hendel is de wielheffer makkelijk te bedienen door slechts één monteur.



Geschikt voor wielen van maximaal 445/65 - 22,5"

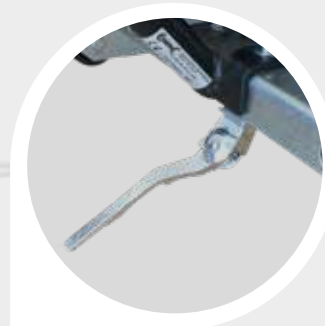

Standaard voor snel en eenvoudig opbergen.



De rollers hebben aan elke zijde drie posities voor verschillende wielmaten.

DEAAL VOOR HET WERKEN MET ZWARE WIELEN VAN VRACHTWAGENS, BUSSEN EN BESTELWAGENS

Max. hefhoogte 665 mm.

Dubbele, kogelgelagerde rollers voor onafhankelijke rotatie en positionering van de wielen.

WD 800

Capaciteit 800 kg.

Gewicht: 136 kg.



Ideaal voor heffen van zware dubbelwielen.



De verstelbare armen maken het mogelijk om wielen met een diameter van 545 mm. tot 1278 mm. te verplaatsen.

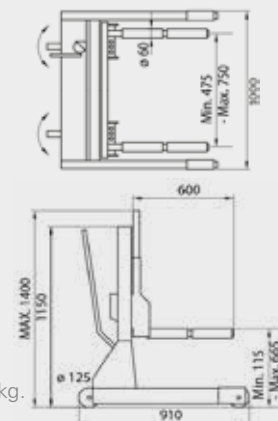

De positionering van de cilinder geeft ruime toegang tot het werkgebied door het open frame.



MAKKELIJK EN VEILIG MONTEREN, DEMONTEREN EN HANTEREN VAN GROTE WIELEN TOT 2400 MM

Dubbelwerkend hydraulisch systeem.
Handenvrij schakelen tussen heffen
en dalen. Veilig en gecontroleerd dalen.





WIELHEFFER LANDBOUW- EN GRAAFMACHINES



Geschikt voor grote wielen met een diameter van 1250 mm tot 2400 mm en een diepte van maximaal 1050 mm.



2 x 4 grote rollers voor betere hanteerbaarheid van banden met diep profiel.

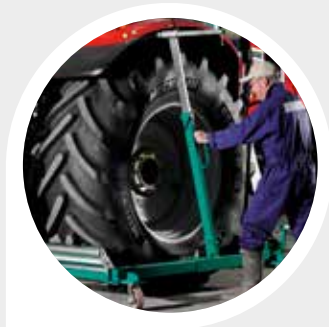

Grote open werkruimte dankzij de ingebouwde hydrauliek.



Handenvrij schakelen tussen heffen en dalen. Veilig en gecontroleerd dalen.

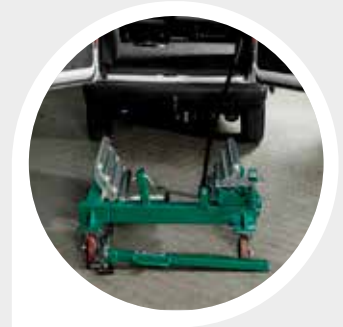

Verrijdbaar: Eenvoudig buiten de werkplaats te gebruiken. Binnen enkele seconden gedemonteerd.



**You
Tube**

Sleutelwoord:
Compac WD 1600

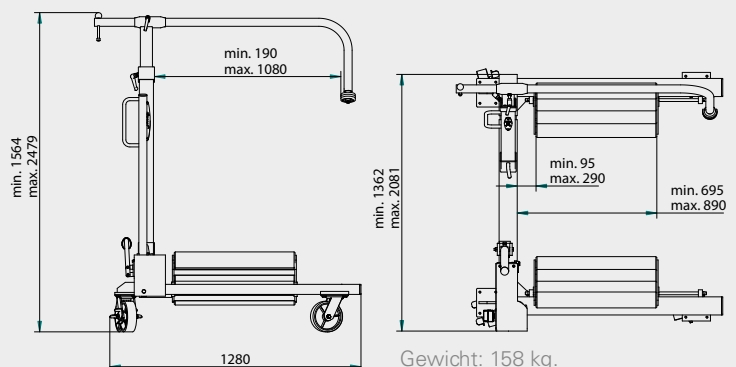



WERKPLAATSKRANEN AUTO'S



ACCESSOIRES



939010
Evenaar.
Capaciteit 500 kg.

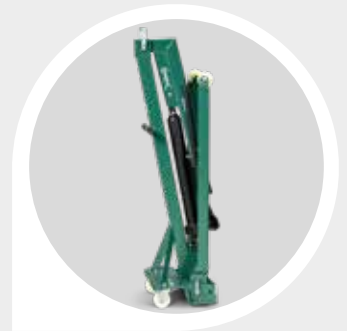

Opvouwbaar. Neemt slechts een beperkte ruimte in. (36 x 42 cm)



CC 055 Capaciteit:

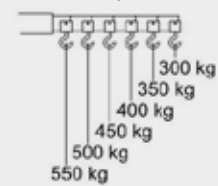

CC 10 Capaciteit:

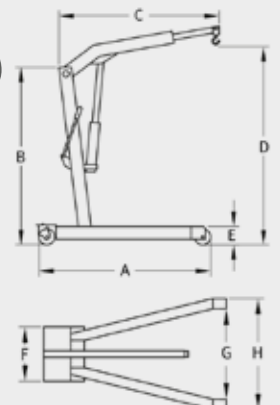
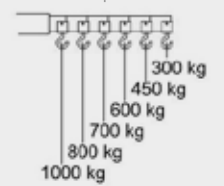

Model	A (mm)	B (mm)	C (mm)	D (mm)	E (mm)	F (mm)	G (mm)	H (mm)	Kg
CC 055	1530	1500	Min. 985 Max. 1435	2120 Max. 550 kg. 2455 Max. 300 kg.	88	440	865	1020	102
CC 10	1530	1500	Min. 985 Max. 1435	2120 Max. 1000 kg. 2455 Max. 300 kg.	88	440	865	1020	102



WERKPLAATSKRANEN

AUTO'S EN INDUSTRIEEL GEBRUIK



Het extra lange bereik zorgt voor bedieningsgemak bij motoren van moderne voertuigen.

De draaibare pomphendel maakt bediening door slechts één monteur mogelijk.



CC 10



Werkplaatskraan met hoog vermogen. Voor industriële toepassingen.

CC 15P



De industriële werkplaatskraan past om een standaard EUR-pallet.

CC 15P Capaciteit:

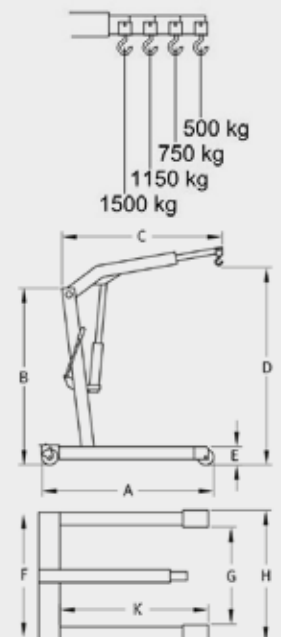

Model	A (mm)	B (mm)	C (mm)	D (mm)	E (mm)	F (mm)	G (mm)	H (mm)	K (mm)	Kg
CC 15P	1720	1860	Min. 1370 Max. 1820	2745 Max. 1500 kg. 3110 Max. 500 kg.	200	1000	850	1015	1570	168



UNIVERSELE TRANSMISSIEKRIKS AUTO'S EN BUSJES



Omkeerbare transmissie-adapter met zadel en rubber pad.

Omkeerbare adapter maakt andere werkzaamheden mogelijk.



Hard verchroomde zuigerstang.

Veerbelast daal-systeem met dodemansknop.

Brede wielbasis voor stabiliteit bij heffen en manoeuvreren met zware last.

Grote zwenkwielen voor goed manoeuvreren.

TJ 525

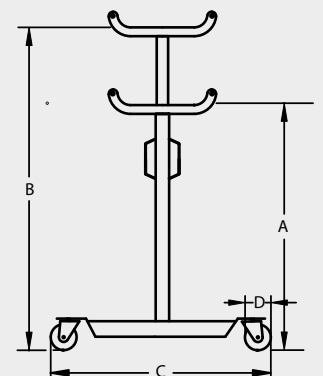

Model	Max (kg)	A (mm)	B (mm)	C (mm)	D (mm)	Kg
TJ 300	300	1095	1930	465 x 565	60	28
TJ 325	325	1170	2020	595 x 535	80	30
TJ 525	525	1170	2020	595 x 535	80	32
TJ 1000	1000	1170	2000	595 x 535	100	38



ACCESSOIRES VOOR TRANSMISSIEKRIKS AUTO'S EN BUSJES

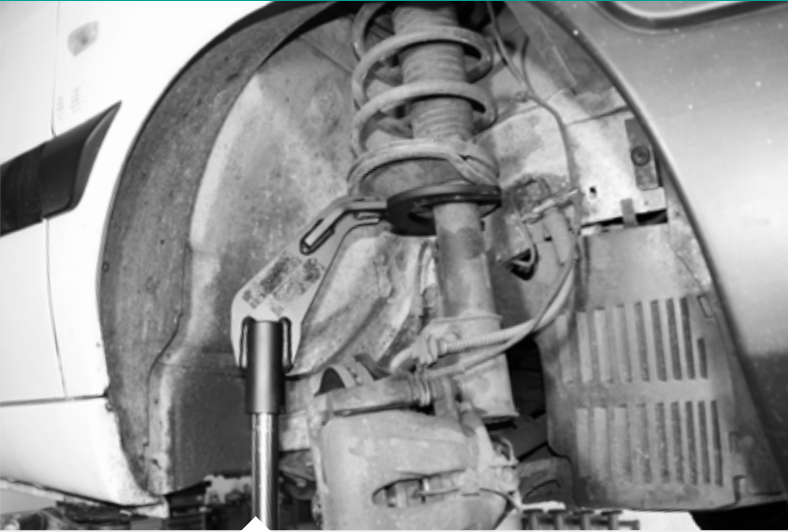

53012/53015

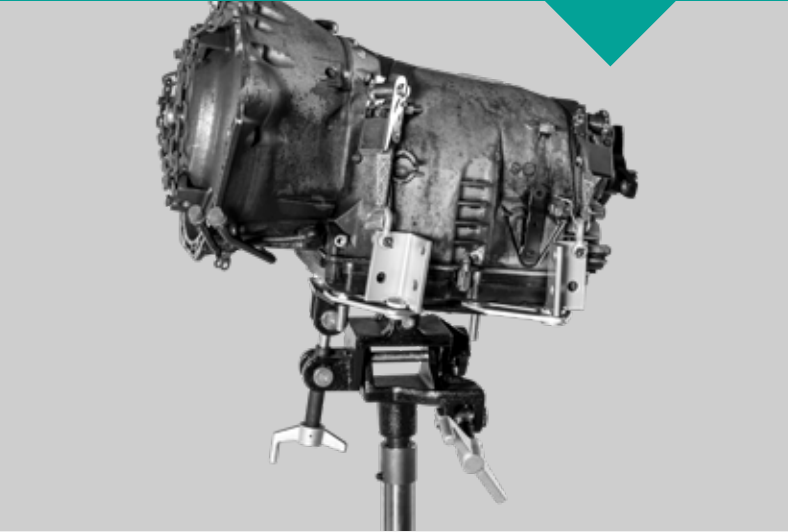

939014

ACCESSOIRES



Model	Nr.
TJ 300	53012
TJ 325	53012
TJ 525	53012
TJ 1000	53015
TJ-T 1300	53015

McPherson ondersteuningshaakjes.

Voor het ondersteunen en vastzetten van de veerpoot wanneer de monteur aan de wielophanging werkt.

De McPherson veerpootsteun voorkomt dat de poot naar beneden komt bij het demonteren van de veerpoot uit de dwarsverbinding.



Model	Nr.
TJ 300	53004
TJ 325	53004
TJ 525	53005
TJ 1000	53006
TJ-T 1300	53006

Vloeistoffenafvoerbak met adapter.

Multifunctionele vloeistoffenafvoerbak met 18,9 liter capaciteit. Ideaal voor snel en eenvoudig afvoeren van olie.



Model	Nr.
TJ 300	53010
TJ 325	53010
TJ 525	53011
TJ 1000	53013
TJ-T 1300	53013

Adapter.

Adapter zonder de vier armen. Voor betere toegang tot plekken met beperkte ruimte.



Model	Nr.
TJ 300	-
TJ 325	-
TJ 525	939014
TJ 1000	939014
TJ-T 1300	939014

Verstelbaar transmissie-gereedschap.

Voor de positionering en veilig werken aan transmissies. Capaciteit 300 kg.

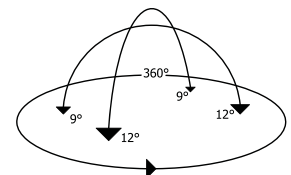



TELESCOPISCHE TRANSMISSIEKRIKS AUTO'S, BUSJES EN 4WD'S



ACCESSOIRES

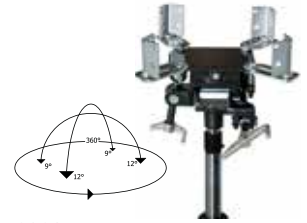

939014
Verstelbaar transmissie-gereedschap. Voor de positionering en veilig werken aan transmissies.

Capaciteit 300 kg.

939014

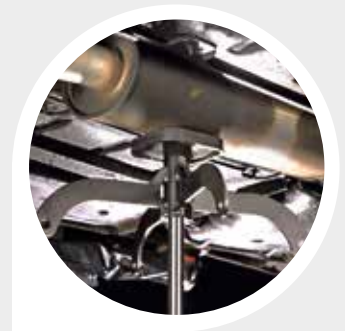
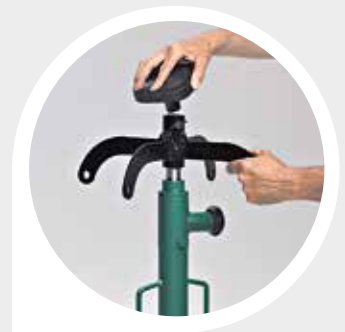

Omkeerbare transmissie-adapter met zadel en rubber pad.

Omkeerbare adapter maakt andere werkzaamheden mogelijk.

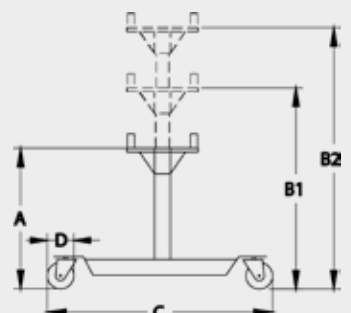

Model	Max (ton)	A (mm)	B1 (mm)	B2 (mm)	C (mm)	D (mm)	Kg
TJ-T 1300	1.3 / 0.5	1000	1500	2010	760 x 640	100	65



TELESCOPISCHE TRANSMISSIEKRIKS VRACHTWAGENS EN BUSSEN



ACCESSOIRES

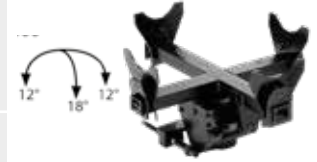

939007
Verstelbaar transmissie-
gereedschap, voor
de positionering en veilig
werken aan transmissies.

Capaciteit 1000 kg.



Drie-traps cilinder met hard
verchroomde piston voor extra
lage minimum hoogte en
extra lange slag.

Hard verchroomde
zuigerstang.

Pompeenheid met twee
snelheden voor snelle
stijging naar werkstuk.

Grote zwenkwielen voor
goed manoeuvreren.



TJ-T 2000

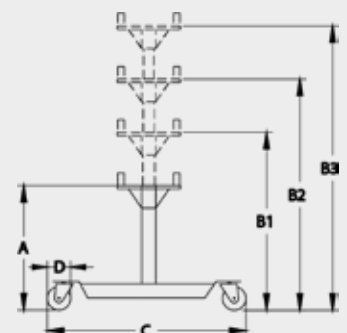

Model	Max (ton)	A (mm)	B1 (mm)	B2 (mm)	B3 (mm)	C (mm)	D (mm)	Kg
TJ-T 2000	2.0 / 1.0 / 1.0	960	1320	1600	1910	1050 x 1050	150	110



VEERCOMPRESSOR AUTO'S EN BUSJES



EFFICIËNT, PROFESSIONEEL EN VEILIG DEMONTEREN EN MONTEREN VAN MCPHERSON VEERPOTEN



STANDAARD



2 veerhouders
(Ø78 - 125 mm en Ø125 - 200 mm)

ACCESSOIRES



929050
Veerpootklem.



McPherson veerpoot gemonteerd in veerpootklem. Accessoires 929050.



Voldoende kracht voor het samenpersen van veren van bijvoorbeeld Ducato, Jumper en Boxer.



Verrijdbaar. Eenvoudig verplaatsbaar tussen verschillende werkplekken. Binnen enkele seconden klaar voor gebruik.



VEERCOMPRESSOR AUTO'S EN BUSJES



You
Tube

Sleutelwoord:
Compac CSC

Eenvoudige toegang tot de
centrale moer bovenop de
veerpoot.



VOERTUIG-SPECIEFIE OPLOSSINGEN



929052

Mercedes A, B, C en E-klasse adapters
(C-klasse tot 2009).

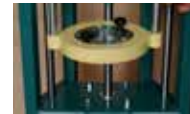

929059

Mercedes C-klasse adapter vanaf 2010.



929051

Veerhouder Ø105 - 182 mm.

Aanbevolen voor:

Renault Megane, Renault Clio,
Citroën C2, Citroën C3, Peugeot 207,
Peugeot 208, Peugeot 307, Fiat Multipla.
(Ook inbegrepen in Mercedes-kit 929052)



929056

Porsche Cayenne en
VW Touareg adapter.



929053

Extra lage lip voor Japanse auto's.



929060

Renault Koleos, Renault Laguna,
Nissan Qashqai adapter.



929057

Veerpootklem voor Chrysler Voyager
en Mercedes.



VOETBEDIENDE WERKPLAATSPERSEN 16 - 25 TON AUTO'S EN BUSJES



ACCESSOIRES



61248

Universele ondersteuning bij verwijderen van lagers.



Verplaatsbare cilinder.

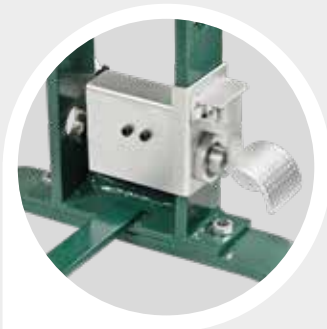

Snelle voetbediende daling van de zuiger op luchtdruk. (FP 20/FP 25)

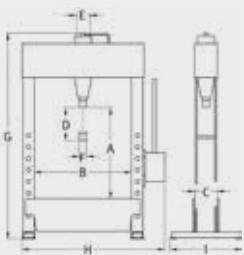

Hard verchroomde zuigerstang.

Zeer lange slag van 240 mm. (FP 20/FP 25)



COMPAC
DENMARK

Twee V-blokken.

Ingebouwde voetbediende ontluchting. (FP 20/FP 25)

Voetbediend voor handenvrije daling en gebruik met last.

FP 25

Luchtaansluiting met waterafscheider. (FP 20/FP 25)

ACCESSOIRES



61100
Persplaat.



61240
Opbergvakken.



Model	Nr.
FP 16	61219
FP 20	61216
FP 25	61216

Persstukken.

7 stuks, Ø12, 16, 18, 20, 22, 25, 30.



Model	Nr.
FP 16	61220
FP 20	61218
FP 25	61218

Kogellager uitdrukset.

4 stuks, Ø 64, 67, 72, 75.



61242
Protectiescherm.

Model	Max (ton)	(mm/stroke)	A (mm)	B (mm)	C (mm)	D (mm)	E (mm)	F (mm)	G (mm)	H (mm)	I (mm)	Kg
FP 16	16	6,0/2,0	1200	550	140	150	65	40	1780	850	600	125
FP 20	20	9,0/1,1	825	600	140	240	90	70	1800	890	505	154
FP 25	25	9,0/1,1	825	600	140	240	90	70	1800	890	505	154



HANDBEDIENDE WERKPLAATSPERSEN 20 - 25 TON AUTO'S EN BUSJES



ACCESSOIRES



61248
Universele ondersteuning bij verwijderen van lagers.



Verplaatsbare cilinder.

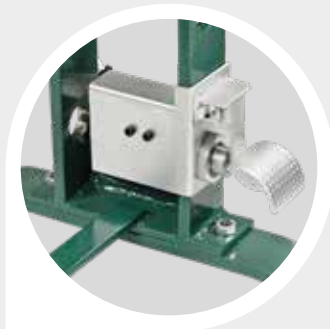

Snelle voetbediende daling van de zuiger op luchtdruk.

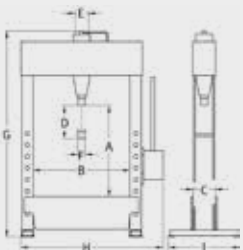

Hard verchroomde zuigerstang.

Zeer lange slag van 240 mm.

Ontluchten met de pomphendel.



Twee V-blokken.

HP 25

Luchtaansluiting met waterafscheider.

ACCESSOIRES



61100.
Persplaat.



61240
Opbergvakken.



Model	Nr.
HP 20	61216
HP 25	61216

Persstukken.
7 stuks, Ø12, 16, 18, 20, 22, 25, 30.



Model	Nr.
HP 20	61218
HP 25	61218

Kogellager uitdrukset.
4 stuks, Ø 64, 67, 72, 75.



61242
Protectiescherm.

Model	Max (ton)	(mm/stroke)	A (mm)	B (mm)	C (mm)	D (mm)	E (mm)	F (mm)	G (mm)	H (mm)	I (mm)	Kg
HP 20	20	9,0/4,0	825	600	140	240	90	70	1800	890	505	154
HP 25	25	9,0/4,0	825	600	140	240	90	70	1800	890	505	154



VOETBEDIENDE WERKPLAATSPERSEN 40 - 50 TON VRACHTWAGENS EN BUSSEN



ACCESSOIRES



61248
Universele ondersteuning bij verwijderen van lagers.

Model	Nr.
FP 40	61248
FP 50	61248



De perstafel hoogte kan snel en veilig aangepast worden, door het tandheugel-lier systeem.



Snelle voetbediende daling van de zuiger op luchtdruk.

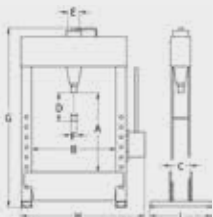

Model	Max (ton)	(mm/stroke)	A (mm)	B (mm)	C (mm)	D (mm)	E (mm)	F (mm)	G (mm)	H (mm)	I (mm)	Kg
FP 40	40	6,0/1,0	750	840	200	300	125	70	1990	1350	630	370
FP 50	50	6,0/1,0	750	840	200	300	125	70	1990	1350	630	370



ACCESSOIRES



61100
Persplaat.



61240
Opbergvakken.



Model	Nr.
FP 40	61216
FP 50	61216

Persstukken.
7 stuks, Ø12, 16, 18, 20, 22, 25, 30.



Model	Nr.
FP 40	61218
FP 50	61218

Kogellager uitdrukset.
4 stuks, Ø 64, 67, 72, 75.



Model	Nr.
FP 40	61243
FP 50	61243

Protectiescherm.



HANDBEDIENDE WERKPLAATSPERSEN 40 - 100 TON VRACHTWAGENS EN Bussen



ACCESSOIRES



61248
Universele ondersteuning bij verwijderen van lagers.

Model	Nr.
HP 40	61248
HP 50	61248
HP 60	-
HP 70	-
HP 100	-



De perstafel hoogte kan snel en veilig aangepast worden, door het tandheugel-lier systeem.



Snelle voetbediende daling van de zuiger op luchtdruk.



ACCESSOIRES



61100
Persplaat.



61240
Opbergvakken.



Model	Nr.
HP 40	61216
HP 50	61216
HP 60	61228
HP 70	61228
HP 100	61233

Persstukken.
7 stuks, Ø12, 16, 18, 20, 22, 25, 30.



Model	Nr.
HP 40	61218
HP 50	61218
HP 60	61229
HP 70	61229
HP 100	61234

Kogellager uitdrukset.
4 stuks, Ø 64, 67, 72, 75.



Model	Nr.
HP 40	61243
HP 50	61243
HP 60	61245
HP 70	61245
HP 100	61247

Protectiescherm.

Model	Max (ton)	(mm/stroke)	A (mm)	B (mm)	C (mm)	D (mm)	E (mm)	F (mm)	G (mm)	H (mm)	I (mm)	Kg
HP 40	40	6,0/2,0	750	840	200	300	125	70	1990	1350	630	370
HP 50	50	6,0/2,0	750	840	200	300	125	70	1990	1350	630	370
HP 60	60	5,0/0,8	760	1005	255	300	160	80	2100	1615	710	680
HP 70	70	5,0/0,8	760	1005	255	300	160	80	2100	1615	710	680
HP 100	100	3,4/0,8	915	1035	305	300	200	100	2200	1637	800	946



ELEKTROHYDRAULISCHE WERKPLAATSPERSEN 40 - 60 TON MET ENKELWERKENDE CILINDER



ACCESSOIRES



61248
Universele ondersteuning bij verwijderen van lagers.

Model	Nr.
EP 40	61248
EP 60	-

≡ **Enkelwerkende cilinder:**
Persen in één richting voor situaties waarbij zwaar gereedschap niet aan de zuigerstang gemonteerd mag worden.



De perstafel hoogte kan snel en veilig aangepast worden, door het tandheugel-lier systeem.



Dankzij de 90 graden scharnierende pomp kan men makkelijker langere werkstukken invoeren.

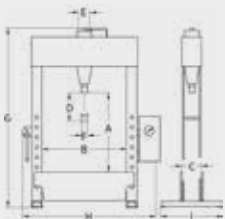

ACCESSOIRES



61100
Persplaat.



61240
Opbergvakken.



Model	Nr.
EP 40	61216
EP 60	61228

Persstukken.
7 stuks, Ø12, 16, 18, 20, 22, 25, 30.



Model	Nr.
EP 40	61218
EP 60	61229

Kogellager uitdrukset.
4 stuks, Ø 64, 67, 72, 75.



Model	Nr.
EP 40	61243
EP 60	61245

Protectiescherm.

Model	Max (ton)	(mm/stroke)	A (mm)	B (mm)	C (mm)	D (mm)	E (mm)	F (mm)	G (mm)	H (mm)	I (mm)	Kg	Kw
EP 40	40	10,0	750	840	200	300	125	70	1990	1480	630	407	2,2
EP 60	60	10,0/5,0	760	1000	255	300	160	80	2100	1680	710	707	2,2



ELEKTROHYDRAULISCHE WERKPLAATSPERSEN 40 - 100 TON MET DUBBELWERKENDE CILINDER



ACCESSOIRES



61248
Universele ondersteuning bij verwijderen van lagers.

Model	Nr.
EP 40 D	61248
EP 60 D	-
EP 100 D	-



De perstafel hoogte kan snel en veilig aangepast worden, door het tandheugel-lier systeem.



Dankzij de 90 graden scharnierende pomp kan men makkelijker langere werkstukken invoeren.

Dubbelwerkende cilinder:
Voor zowel drukken als trekken.



EP 40 D

Model	Max (ton)	(mm/stroke)	Max (ton)	A (mm)	B (mm)	C (mm)	D (mm)	E (mm)	F (mm)	G (mm)	H (mm)	I (mm)	Kg	Kw
EP 40 D	40	10,0	6	750	840	200	300	125	70	1990	1480	630	407	2,2
EP 60 D	60	10,0/5,0	6	760	1000	255	300	160	80	2100	1680	710	707	2,2
EP 100 D	100	10,0/1,4	4	915	1035	305	300	200	100	2200	1780	800	996	2,2

ACCESSOIRES



61100
Persplaat.



61240
Opbergvakken.



Model	Nr.
EP 40 D	61216
EP 60 D	61228
EP 100 D	61233

Persstukken.
7 stuks, Ø12, 16, 18, 20, 22, 25, 30.



Model	Nr.
EP 40 D	61218
EP 60 D	61229
EP 100 D	61234

Kogellager uitdrukset.
4 stuks, Ø 64, 67, 72, 75.



Model	Nr.
EP 40 D	61243
EP 60 D	61245
EP 100 D	61247

Protectiescherm.



ASSTEUNEN 2 - 12 TON

POTKRIKS 3 - 50 TON

AUTO'S, VRACHTWAGENS EN LANDBOUWMACHINES



SHARK&CO



ASSTEUNEN

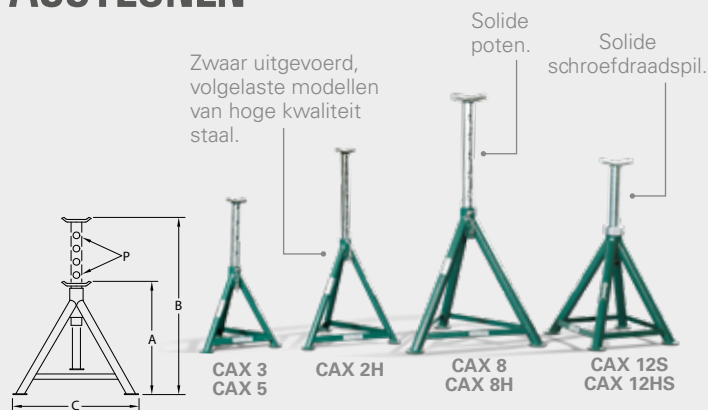

Model	Max (ton)	A (mm)	B (mm)	C (mm)	P	Kg
CAX 2H	2	420	650	410	5	5,6
CAX 3	3	320	560	330	5	4,6
CAX 5	5	380	600	360	5	6,9
CAX 8	8	400	600	400	5	10,9
CAX 8H	8	600	980	580	6	15,4
CAX 12S	12	340	500	290	Spindel	11,8
CAX 12HS	12	500	740	410	Spindel	15,6

POTKRIKS



Kan horizontaal worden gebruikt. Beperkte slag.



Model	Max (ton)	A (mm)	B (mm)	C (mm)	D (mm)	E (mm)	F (mm)	Kg
CBJ 3	3	193	120	60	373	110x103	26	3,4
CBJ 5	5	210	136	70	416	122x115	30	4,5
CBJ 10	10	230	150	80	460	132x120	36	5,9
CBJ 15	15	230	150	60	440	144x134	43	7,3
CBJ 20	20	242	150	60	452	159x143	46	9,5
CBJ 30	30	275	165	-	440	169x153	49	12,4
CBJ 50	50	265	160	-	425	210x176	83	25,7
CBJ-T 10	10	215	247	78	540	150x145	37	9,8

Compac behoudt zich het recht voor producten uit het programma te verwijderen en/of producten te leveren die afwijken van de illustraties en specificaties.

Compac Hydraulik A/S

Strandhusevej 43 // 7130 Juelsminde // Denmark // Tel: +45 75 69 37 22 // info@compac.dk
www.compac.dk